



Issue: 03
Part Number: 31500JMF

LUNA2000-(215-2S10, 215-2S12) Smart String ESS

Quick Guide

EN

ZH



EN Before installing the equipment, read the user manual carefully to get familiar with product information and safety precautions. The product warranty does not cover equipment damage caused by failure to follow the storage, transportation, installation, and usage guidelines specified in this document and the user manual. Scan the QR code on the cover of this document to view the user manual and safety precautions. The information in this document is subject to change without notice. Every effort has been made in the preparation of this document to ensure accuracy of the contents, but all statements, information, and recommendations in this document do not constitute a warranty of any kind, express or implied.

ZH 安装设备前请详细阅读用户手册，了解产品信息及安全注意事项。未按照本文档与用户手册的内容存储、搬运、安装和使用设备而导致设备损坏，不在设备质保范围内。您可以扫描本文封面处的二维码，查阅用户手册和安全注意事项等信息。由于产品版本升级或其他原因，本文档内容会不定期进行更新。除非另有约定，本文档仅作为使用指导，文档中的所有陈述、信息和建议不构成任何明示或暗示的担保。

1

EN Product Appearance

ZH 产品外观

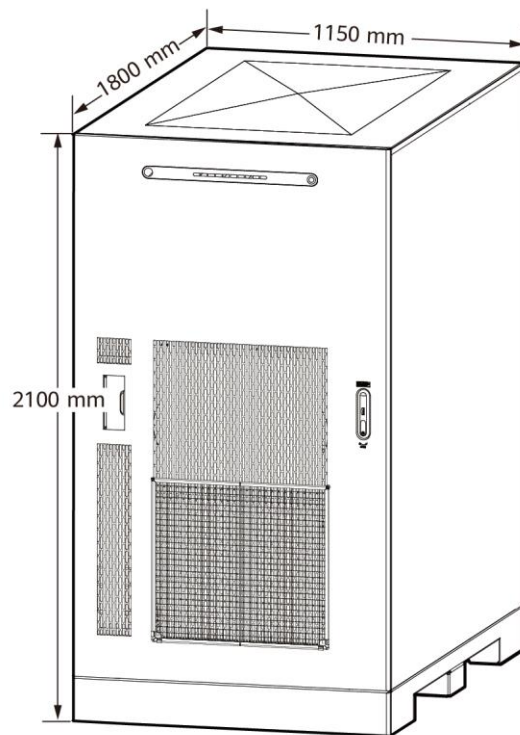

2

EN Installation and Maintenance Clearances

ZH 安装维护空间

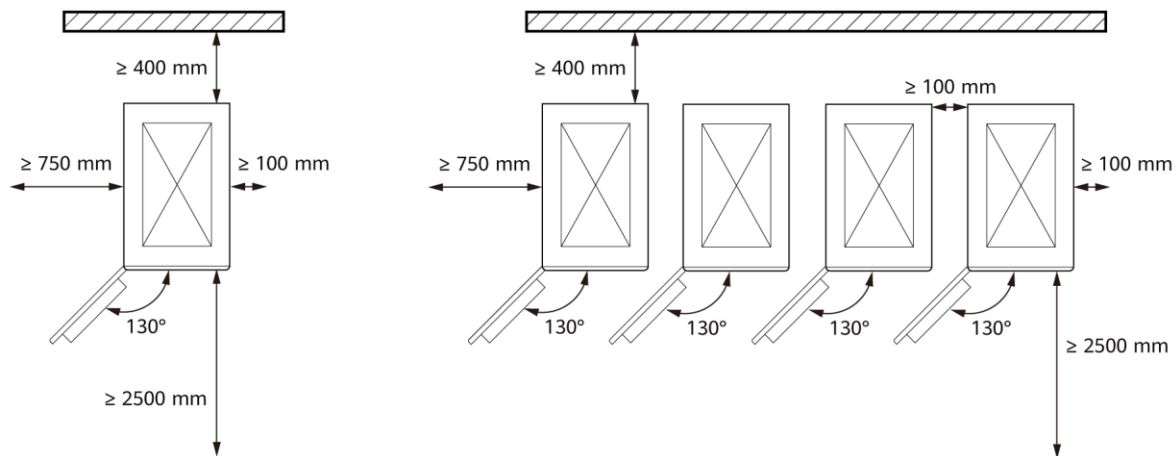

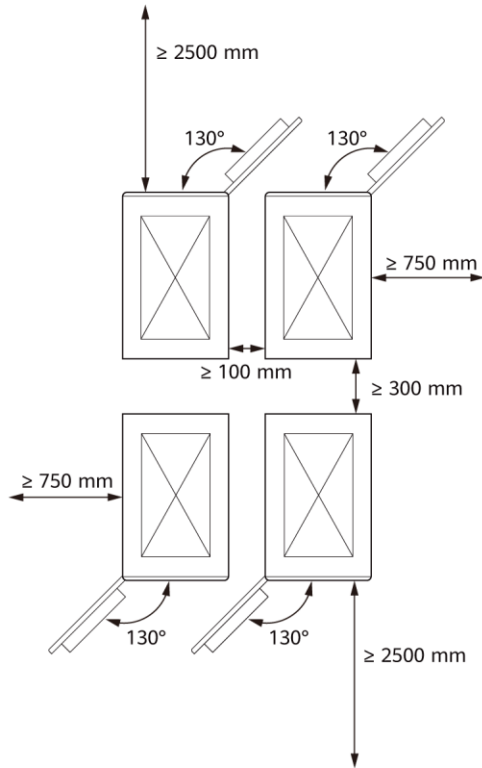

3

EN Installing the ESS

ZH 安装储能系统

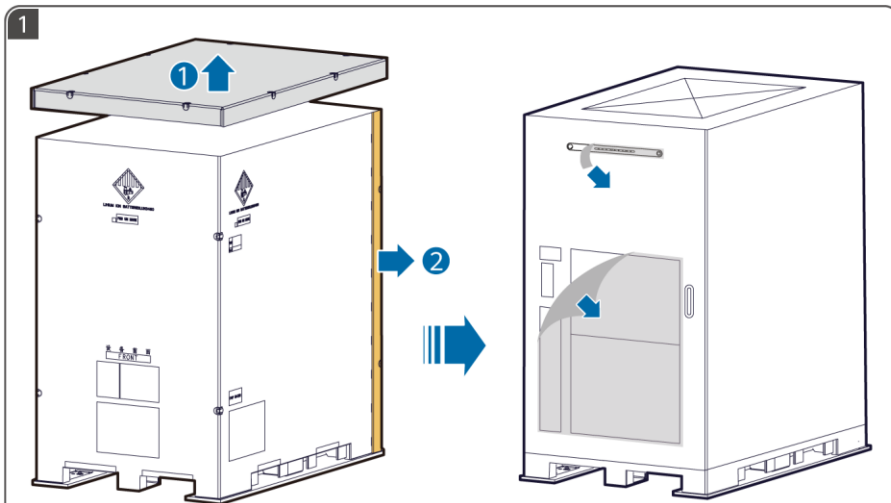

EN Properly keep the top cover of the outer packaging, as it will be used to facilitate locating the ESS.

ZH 外包装顶盖将用于辅助定位储能柜位置，请妥善保存。

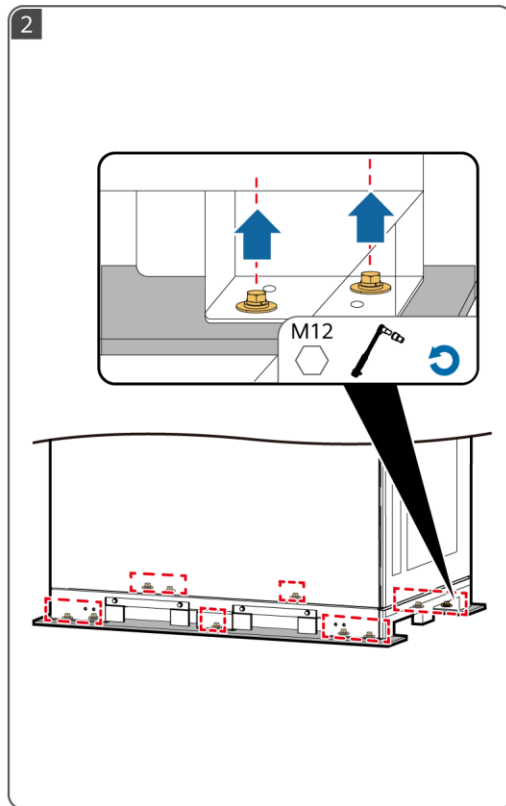

3 Plan 1

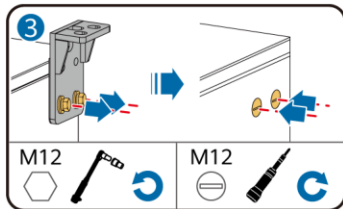
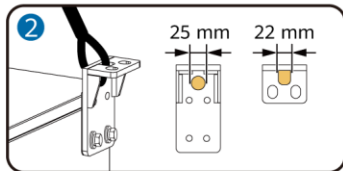
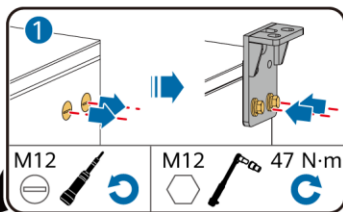
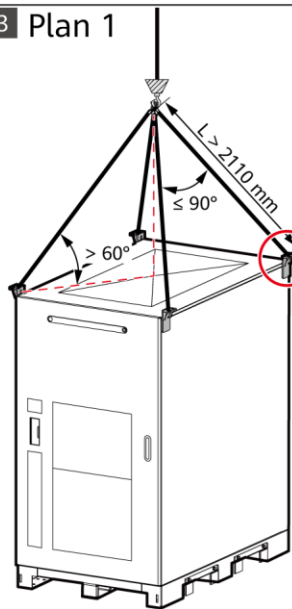

EN Crane: hoisting capacity ≥ 3 t; operating radius ≥ 2 m

ZH 吊车起吊能力 ≥ 3 t; 工作半径 ≥ 2 m。

Plan 2

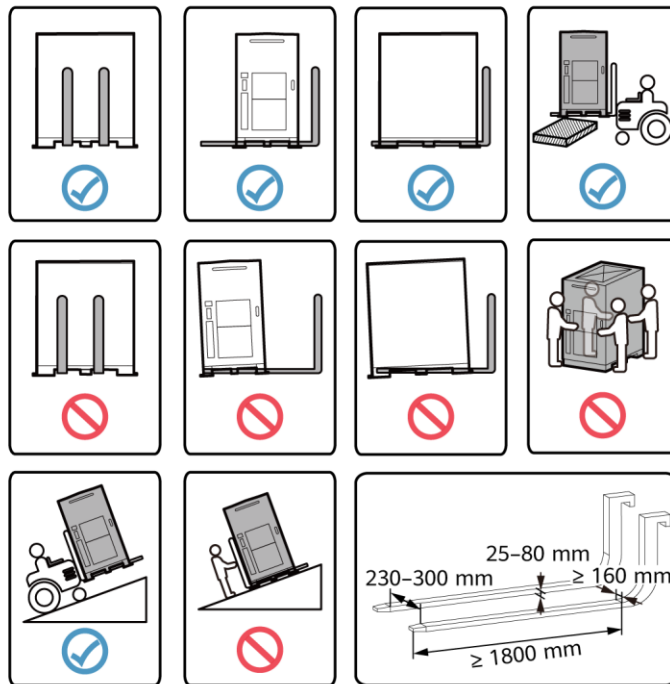

EN Forklift: load-bearing capacity ≥ 3 t

ZH 叉车承重能力 ≥ 3 t。

EN If the ESS is not positioned stably, use a spacer to level the ESS before securing it.

ZH 储能系统不平稳时，在固定前，可使用调平垫片进行调平。

4 Plan 1

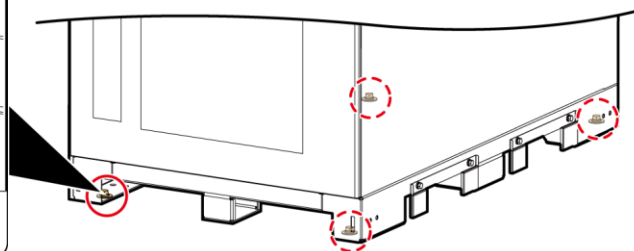
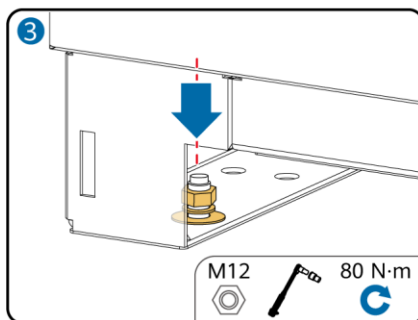
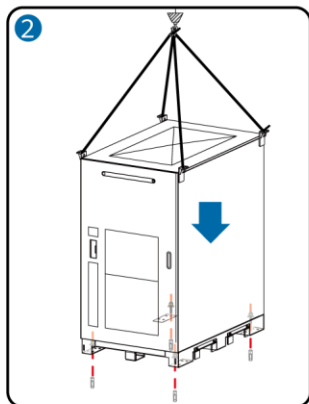
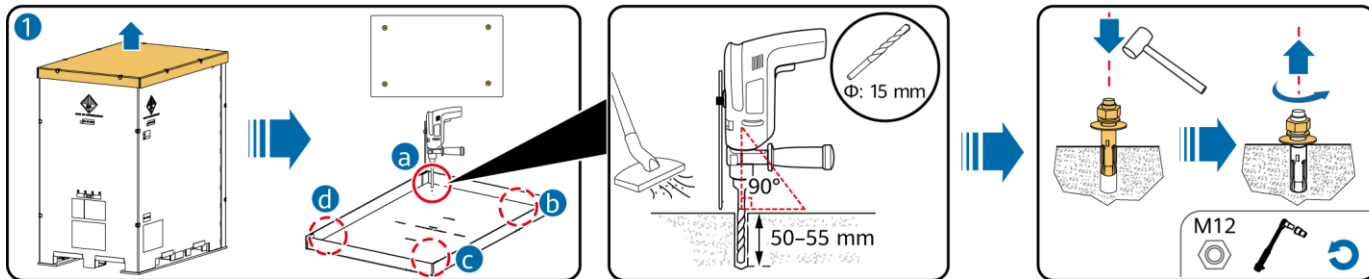

4

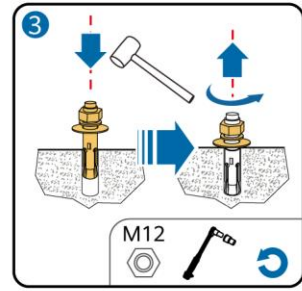
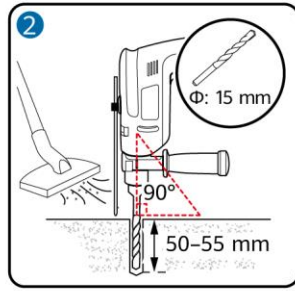
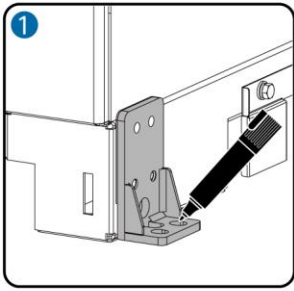

Plan 2

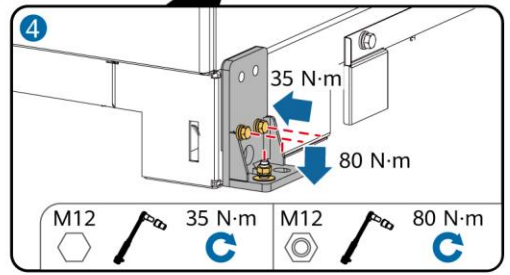
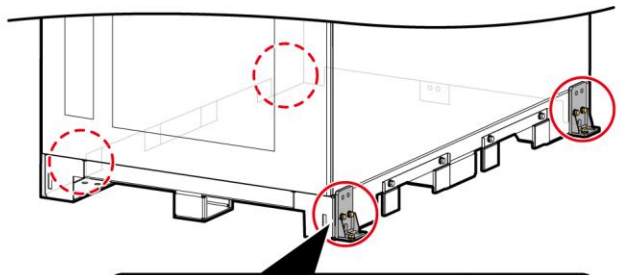

Plan 3

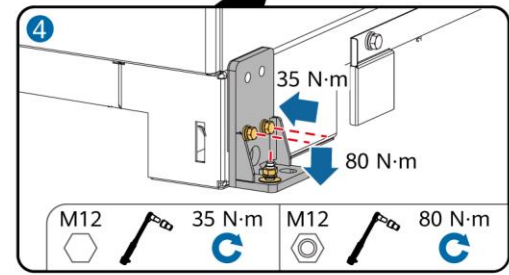
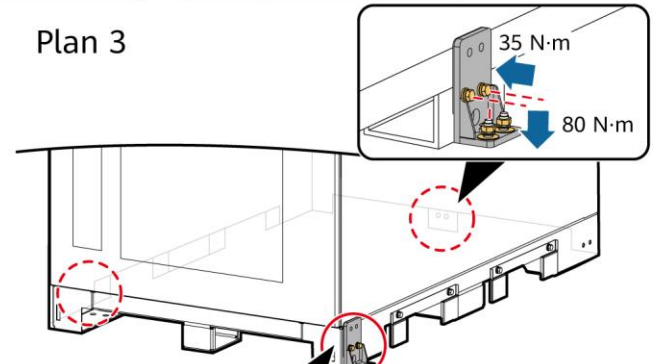

4

EN Installing Ground Cables

ZH 安装保护地线

Plan 1

EN Single-core outdoor copper/copper-clad aluminum/aluminum alloy cable (prepared by the customer)

ZH 单芯户外铜芯/铜包铝/铝合金线缆 (用户自备)

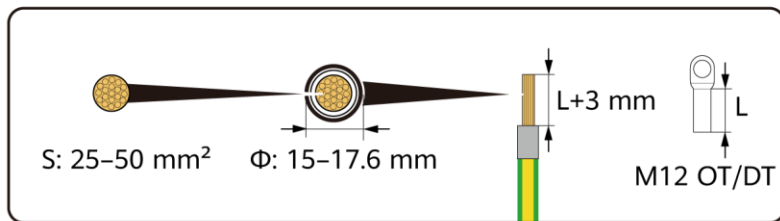
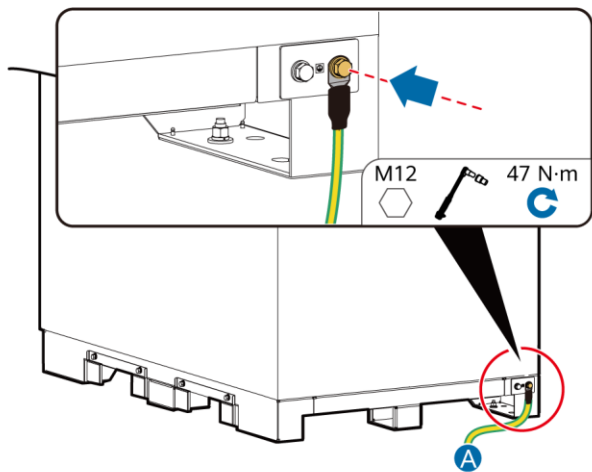

A **EN** Customer's ground grid

ZH 客户侧接地网

Plan 2

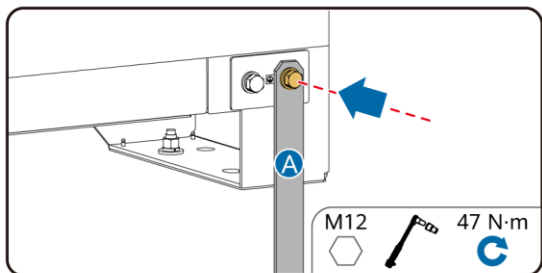

- A** EN Hot-dip zinc-coated flat steel sheet (prepared by the customer)
- ZH 热镀锌扁钢 (用户自备)

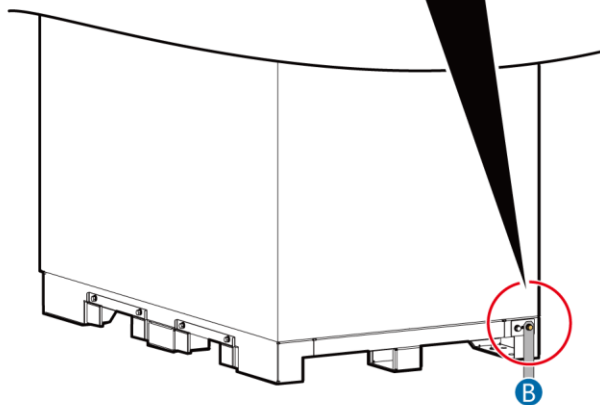

- B** EN Customer's ground grid
- ZH 客户侧接地网

5

EN Installing Cables

ZH 安装线缆

EN The cable size must comply with local cable standards. The factors that affect cable selection include the rated current, cable type, routing mode, ambient temperature, and maximum expected line loss.

ZH 线缆线径的选取应符合当地线缆标准。影响线缆选取的因素有：额定电流、电缆类型、敷设方式、环境温度和最大期望线路损耗。

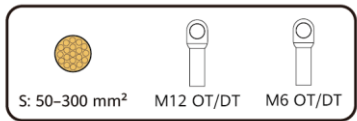
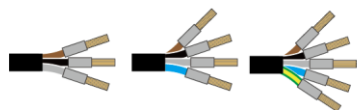

EN PCS AC power cable to the mains (prepared by the customer)

ZH PCS市电交流线（用户自备）

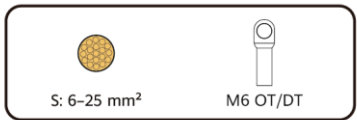

EN AC input power cable for the auxiliary power supply from the mains (prepared by the customer)

ZH 辅助供电市电交流输入线（用户自备）



EN UPS AC input power cable (prepared by the customer)

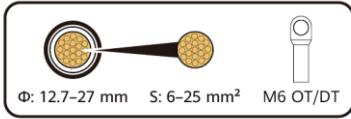

ZH UPS交流输入线（用户自备）



EN Four-core or eight-core single-mode armored cable with a transmission wavelength of 1310 nm (prepared by the customer)

ZH 支持传输波长为1310nm的4芯或8芯单模铠装光缆（用户自备）

5

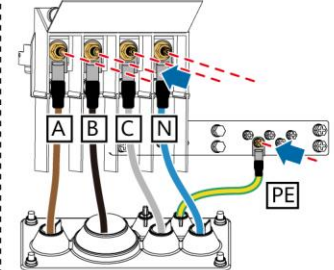
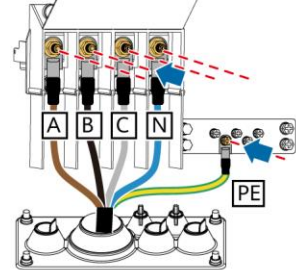
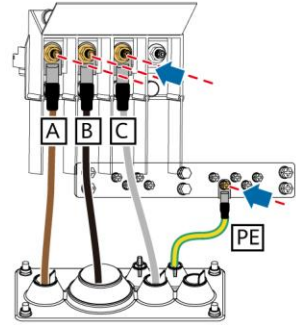
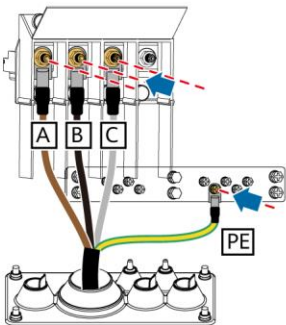
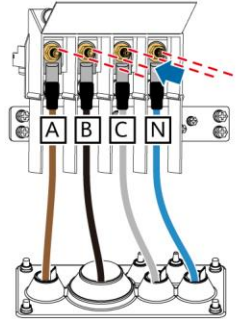
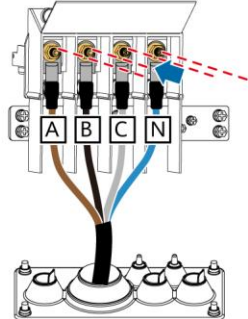
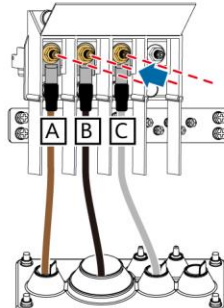
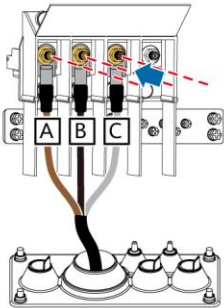

A	B	C	N	M12		40 N·m		PE	M6		5 N·m	

6

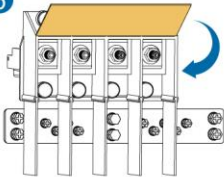

EN Installing AC Input Power Cables for the Auxiliary Power Supply

ZH 安装辅助供电交流输入线

Plan 1

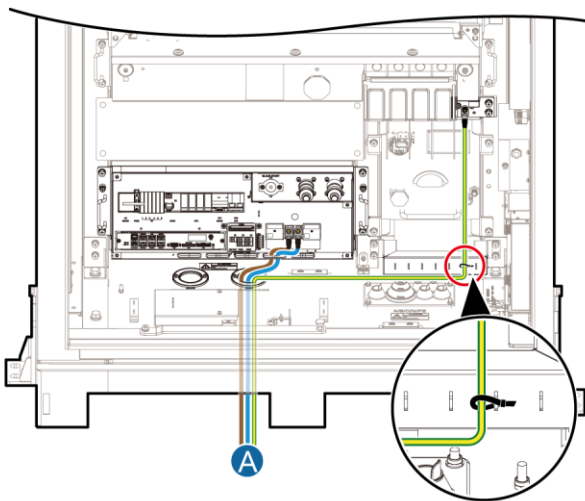

A **EN** Power distribution cabinet

ZH 配电柜

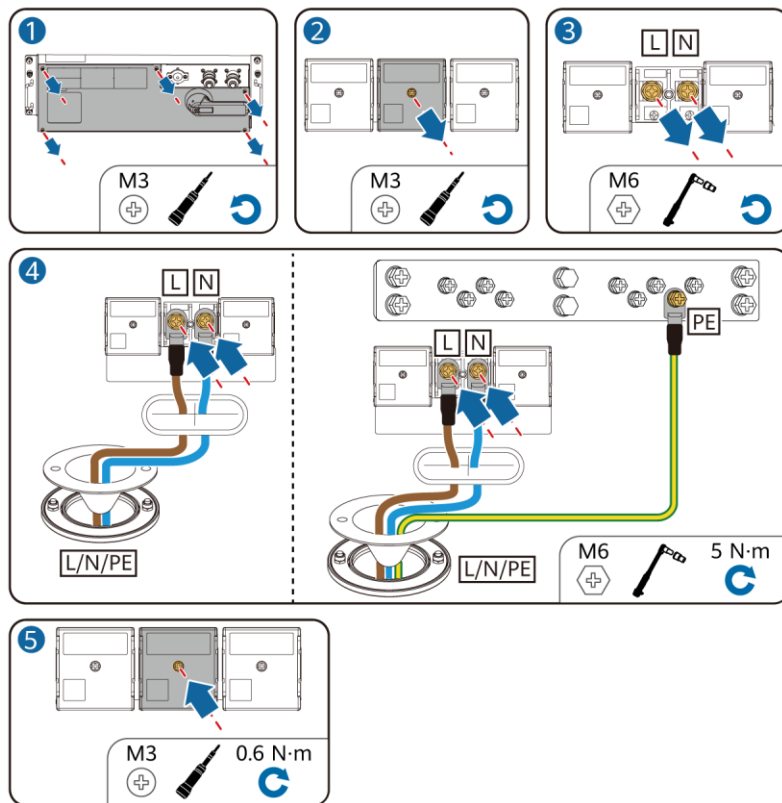

Plan 2

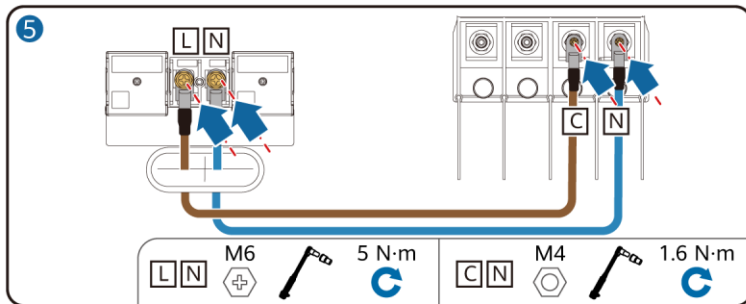
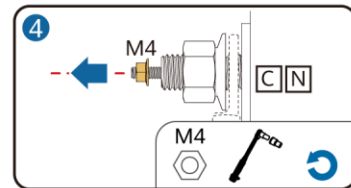
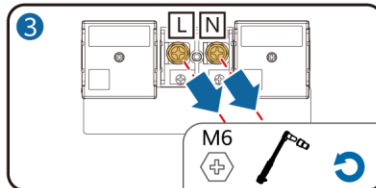
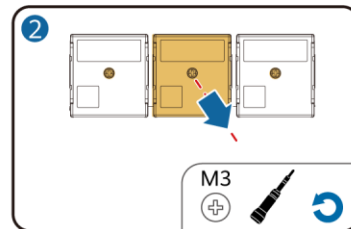
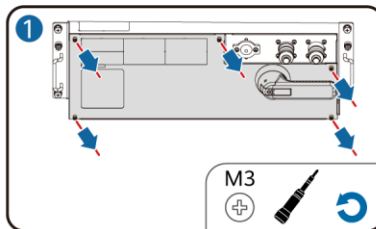
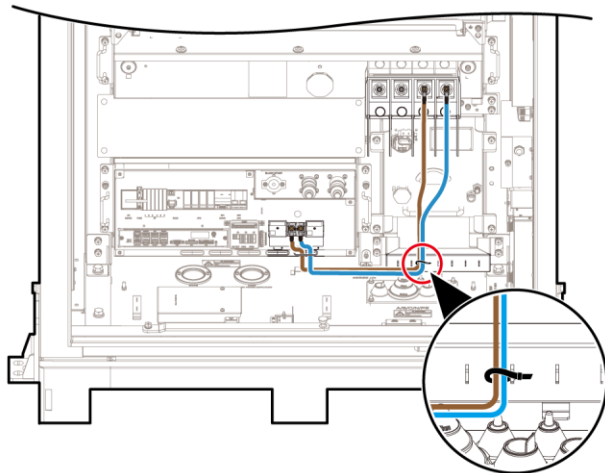

EN When the PCS is used to provide the auxiliary power supply, the power supply to the PCS will be disconnected at the same time if the mains power is off.

ZH 当采用PCS为辅助电源供电时，一旦市电断开，PCS会同时失去电源供应。

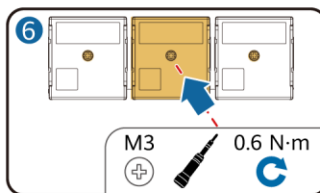

EN Installing UPS Cables (Off-Grid Scenario)

ZH 安装UPS线缆（离网场景）

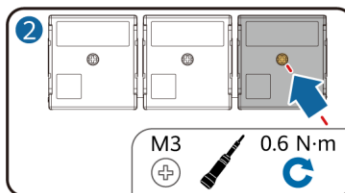
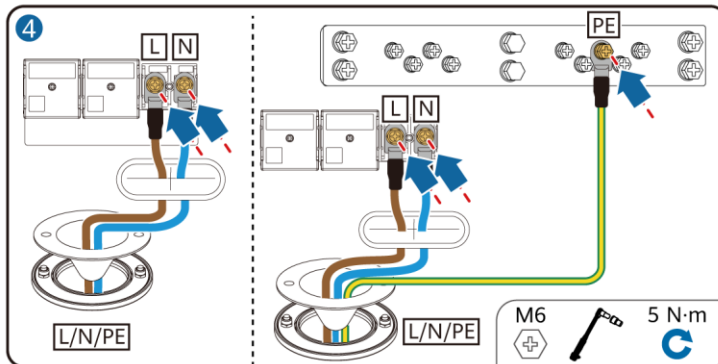
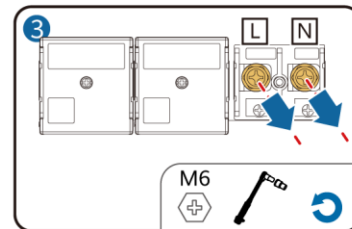
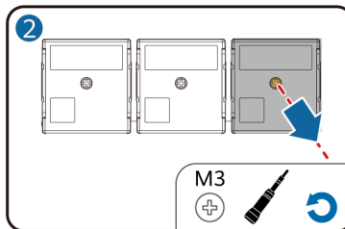
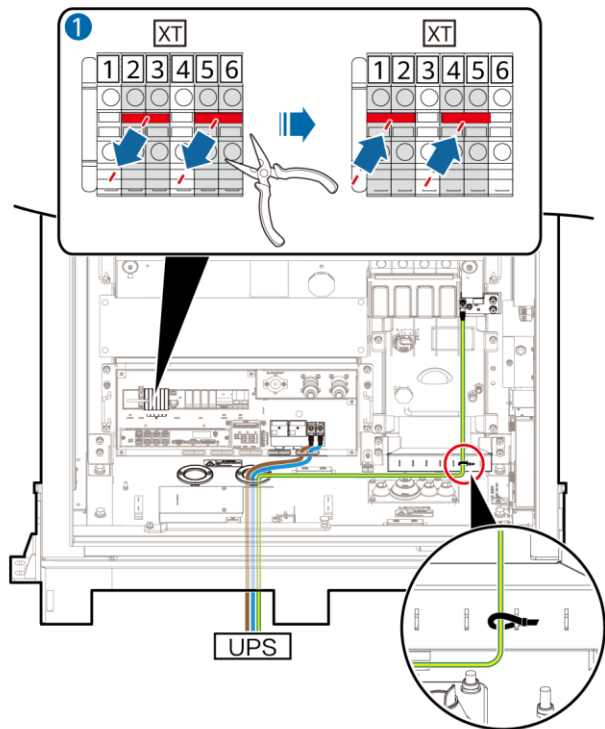

EN (Optional) Installing the SmartLogger

ZH (可选) 安装SmartLogger

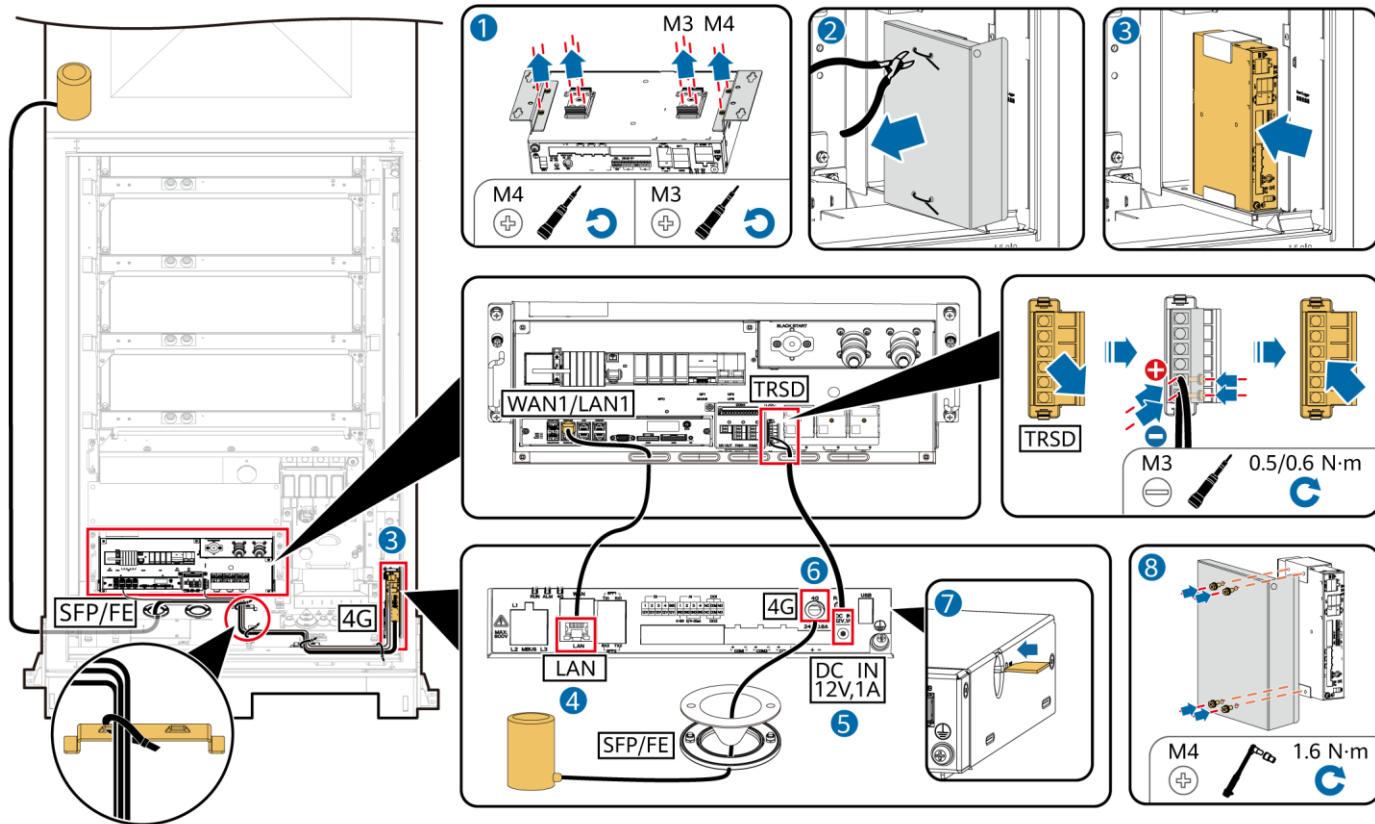

EN Installing FE Communications Cables

ZH 安装FE通信线

Plan 1

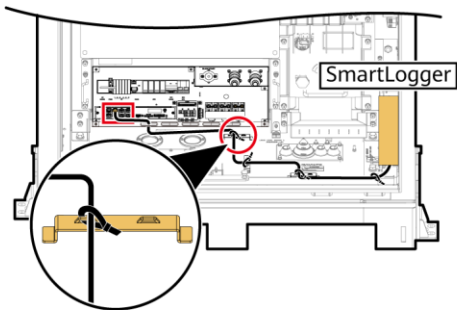

Plan 2

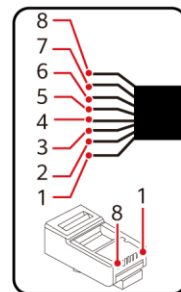
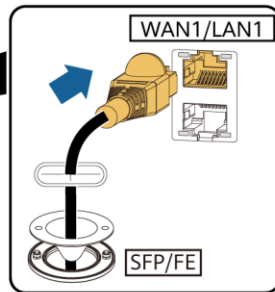
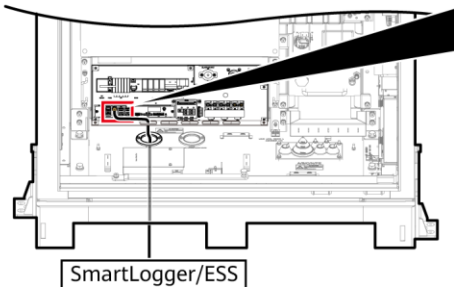

	EN	ZH
1	White-and-orange	白橙
2	Orange	橙
3	White-and-green	白绿
4	Blue	蓝
5	White-and-blue	白蓝
6	Green	绿
7	White-and-brown	白棕
8	Brown	棕

EN Installing Optical Fiber Communications Cables

ZH 安装光纤通信线

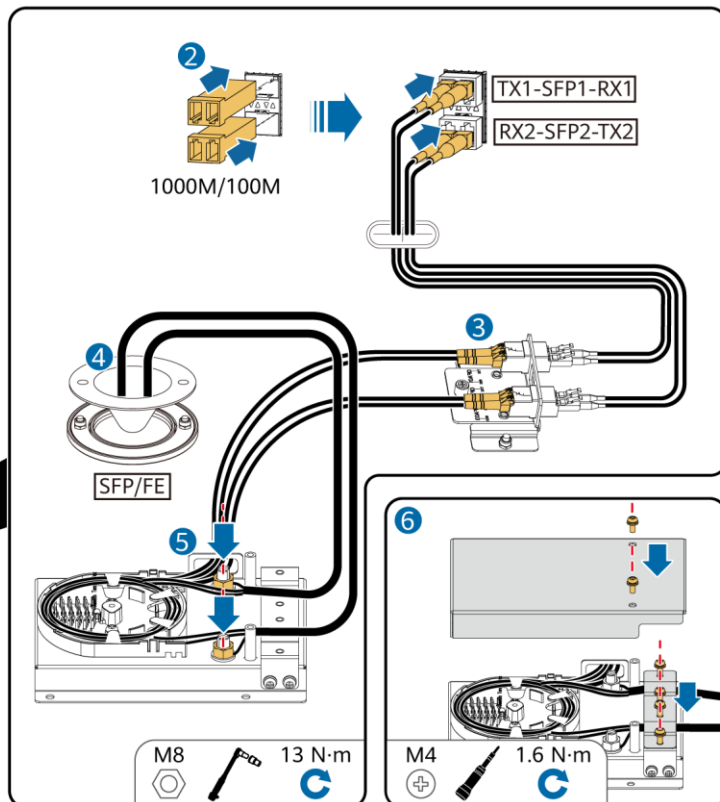
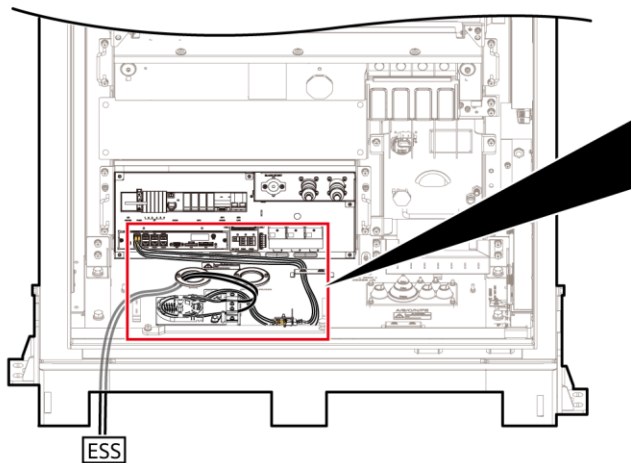
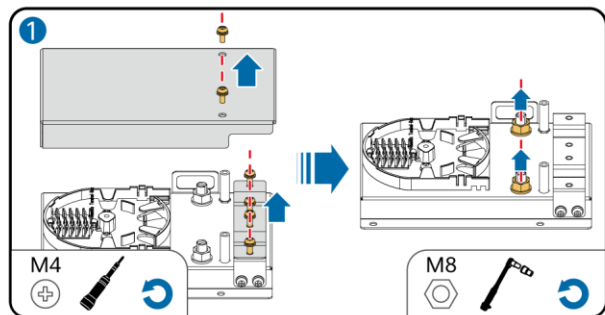

EN Installing Battery Pack Cables

ZH 安装电池包线缆

LUNA2000-215-2S10
LUNA2000-215-2S12

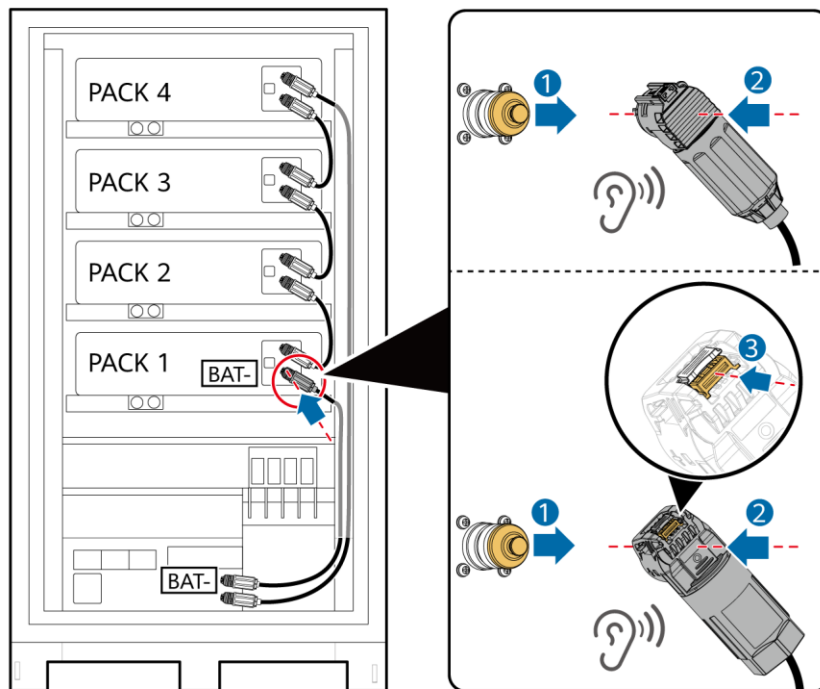

EN Follow-up Procedure

ZH 接线后处理

1

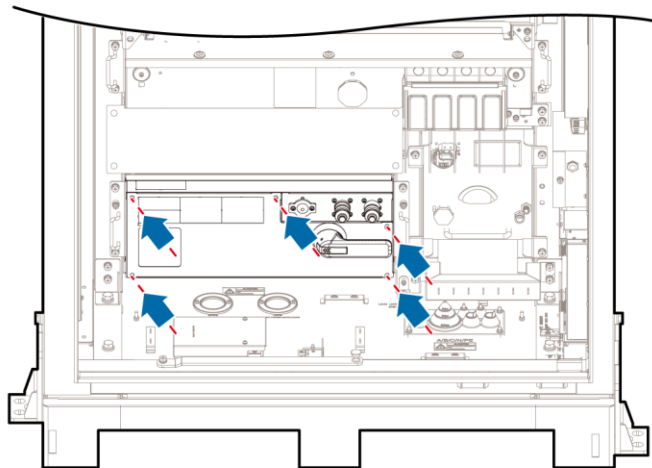

M3
0.6 N·m

2

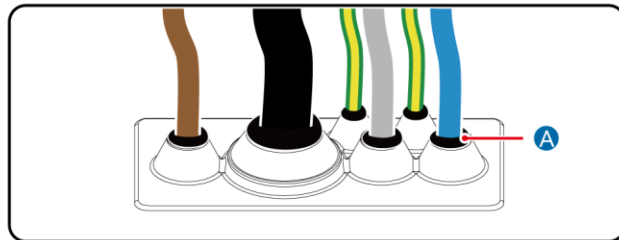
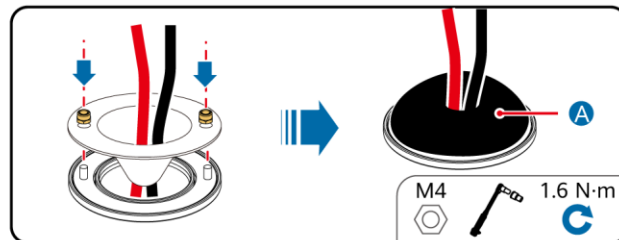

A **EN** Sealing putty

ZH 密封泥

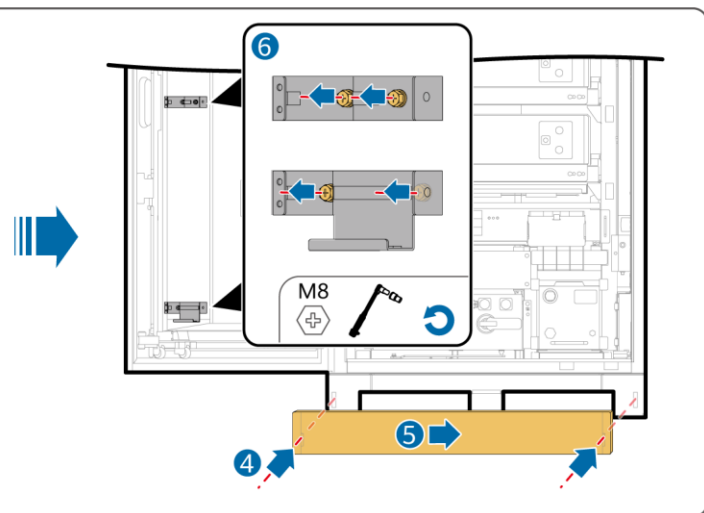
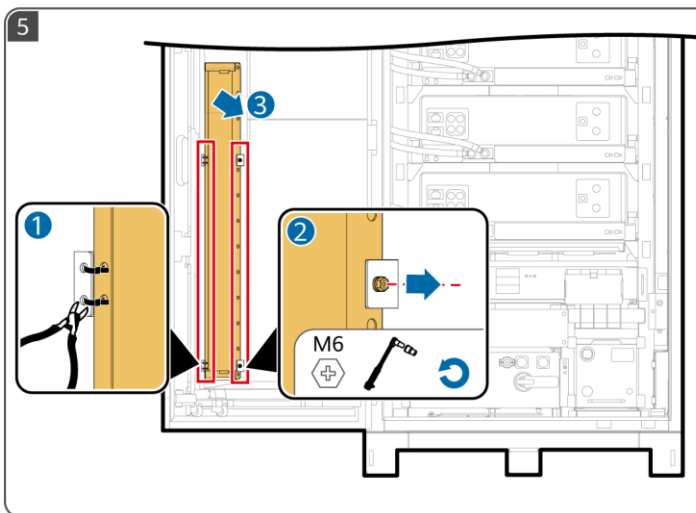
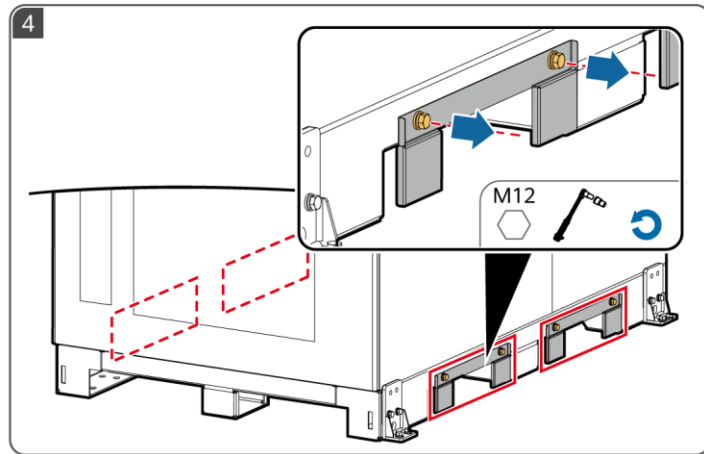
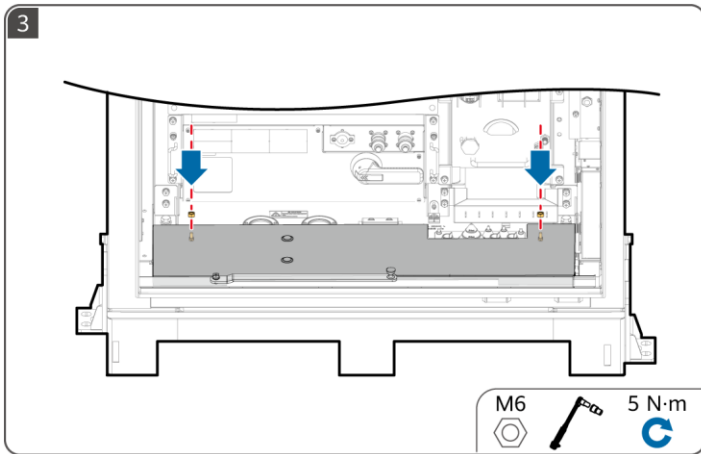

6

EN Check Before Power-On

ZH 上电前检查

EN	Check Item	Acceptance Criteria
1	Equipment exterior	<ul style="list-style-type: none"><input type="checkbox"/> The equipment is intact and free from rust and paint flake-off. If the paint flakes off, repair the damaged paint.<input type="checkbox"/> The labels on the equipment are clear. Damaged labels must be replaced.
2	Cable exterior	<ul style="list-style-type: none"><input type="checkbox"/> Cable sheathings are intact and not damaged.<input type="checkbox"/> Cable hoses are intact.
3	Cable connection	<ul style="list-style-type: none"><input type="checkbox"/> Cables are connected in the designed positions.<input type="checkbox"/> Terminals are prepared as required and securely connected.<input type="checkbox"/> Labels on both ends of each cable are clear and specific, and attached in the same direction.
4	Cable routing	<ul style="list-style-type: none"><input type="checkbox"/> Electrical and extra low voltage (ELV) cables are routed separately.<input type="checkbox"/> Cables are neat and tidy.<input type="checkbox"/> Cable tie joints are evenly cut without burrs.<input type="checkbox"/> Cables are placed properly with slack at bending points to avoid stress.<input type="checkbox"/> Cables are routed neatly without twists or crossovers in the cabinet.
5	Switch	<ul style="list-style-type: none"><input type="checkbox"/> The RCM disconnecter is OFF. (Optional. This item applies only when there is an RCM disconnecter.)

ZH	检查项	验收标准
1	设备外观	<input type="checkbox"/> 设备外观完好，无损坏，无锈蚀和掉漆。如有掉漆，请进行补漆操作。 <input type="checkbox"/> 设备标签清晰可见，损坏的标签要及时更换。
2	线缆外观	<input type="checkbox"/> 线缆防护层包裹完好无明显损坏。 <input type="checkbox"/> 穿管线缆软管完好
3	线缆连接	<input type="checkbox"/> 线缆连接位置与设计相同。 <input type="checkbox"/> 端子制作符合规范，连接牢固可靠。 <input type="checkbox"/> 各线缆两端标签清晰明确，标签朝向一致
4	线缆布线	<input type="checkbox"/> 走线满足强弱电分离原则。 <input type="checkbox"/> 线缆整齐、美观。 <input type="checkbox"/> 线扣接头剪齐，无尖刺外露等现象。 <input type="checkbox"/> 在转弯处按要求留出余量，不得拉紧。 <input type="checkbox"/> 走线平直、顺滑，机柜内线缆无交叉。
5	开关	<input type="checkbox"/> 簇控制盒隔离开关处于OFF状态。（可选，有簇控制盒隔离开关时执行该操作）

7

EN Power-On

ZH 上电操作



- EN**
1. Wear insulated gloves and use insulated tools to prevent electric shock or short circuits.
 2. During the power-on procedure, monitor the system for faults. If you detect any faults, power off the ESS, rectify the faults, and then continue with the procedure.
 3. If batteries are fully discharged or overdischarged during system installation and commissioning, charge the batteries promptly to prevent damage due to overdischarge.
 4. Storing batteries with low SOC may cause damage due to overdischarge. Charge the batteries promptly to prevent damage.
 5. If the ESS has not been used for six months or longer after being installed, it must be checked and tested by professionals before operation.
- ZH**
1. 请佩戴绝缘手套，使用绝缘工具，避免发生电击伤害或短路故障。
 2. 上电过程中同时观察，发现异常现象立即对储能系统下电，并查明原因，解决后方可继续上电。
 3. 系统安装调试过程中导致电池放空或过放，请对电池及时补电，否则可能导致电池因过放而损坏。
 4. 电池低电量状态存储可能导致电池过放损坏，请及时进行补电。
 5. 储能系统装配后超半年未运行使用，需经过专业人员检查和测试才能投入运行使用。

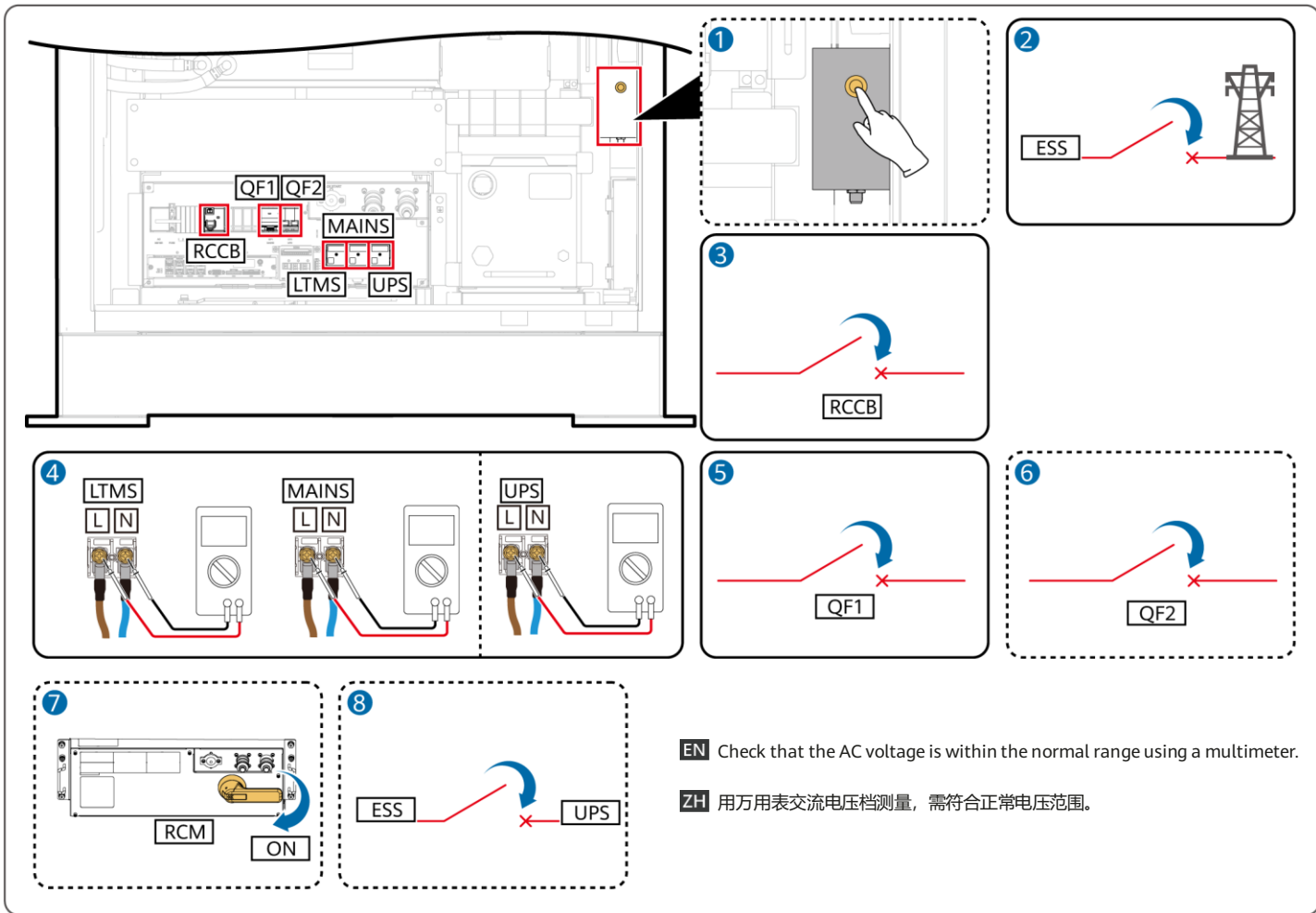



<https://digitalpower.huawei.com>

EN Path: **About Us > Contact Us > Service Hotlines**

ZH 具体路径为：“关于我们 > 联系我们 > 服务热线”



<https://digitalpower.huawei.com/robotchat/>



Huawei Digital Power Technologies Co., Ltd.

Huawei Digital Power Antuoshan Headquarters

Futian, Shenzhen 518043

People's Republic of China

digitalpower.huawei.com